

# LCD-SW900-USB Manual Control Panel

## User Manual

The Latest Version 2014



# 1. Exterior Parameters

Casing Material: ABS

Display Material: High Hardness Acrylic (the same hardness value as tempered glass).

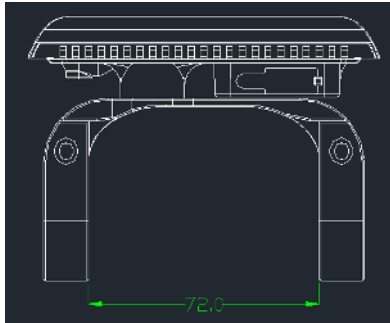

USB

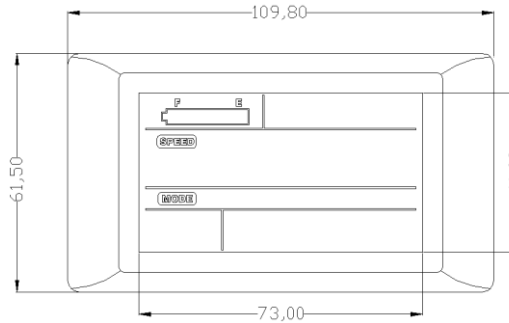

Front View

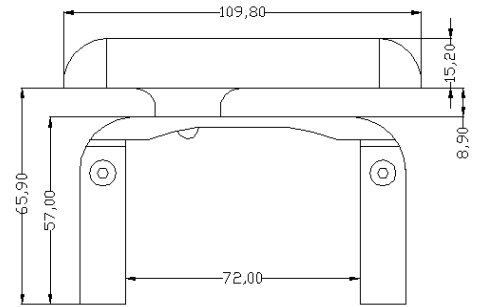

Side Vie

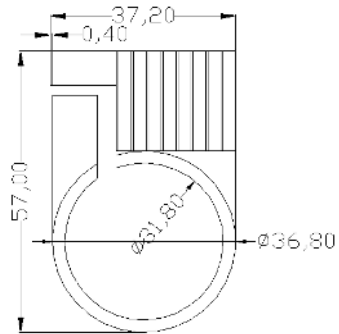

Side View of the Support Stand

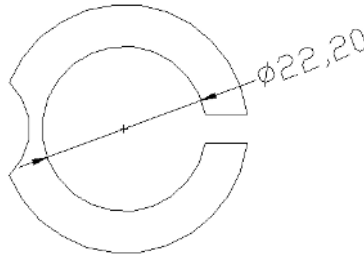

Optional: Converter Ring  
 $\phi 22.2\text{mm} / 25.4\text{mm}$

## 2. Operating Voltage and Connections

a. **Operating Voltage:** DC24V / 36V Compatible, 36/48V Compatible (set by the control panel). Other operating voltage can be customized.

b. **Connections:**

Standard connector sequence

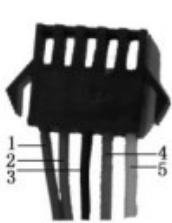

Controller Connector



Panel Outlet Terminal



Wire Connector

**Standard Connector Sequence Table**

Sequence No.	Wire Colour	Functions
1	Red (VCC)	Panel Power Cord
2	Blue (K)	Controller Power Cord
3	Black (GND)	Panel Ground Wire
4	Green (RX)	Panel Data Receiving Wire
5	Yellow (TX)	Panel Data Sending Wire

## Extended Functions

**Light:** Brown (DD): The positive electrode of the light

White (GND): The negative electrode of the light.

The wire colours of the PWM Voltage Motor Power Controller and the independent speed sensor will be defined otherwise.

Note: Some products are equipped with waterproof connectors, whose internal wire colors cannot be determined from outside.

### 3. Functions

#### a. Display

Speed Display, Motor Power Ratio Display, Battery Level Display, Error Indication, Total Mileage, Single Mileage, Cruise Control, Single Running Time, Light Signal

#### b. Control and Settings

Power Switch, Front Light Control, 6km/h Inching Control, Wheel Diameter Setting, Top Speed Setting, Idleness Time Setting for Auto-Hibernation, Backlight Brightness Setting, Voltage Level Setting

#### c. Communications Protocol: UART

#### Display Readings (display at start for 1 second)

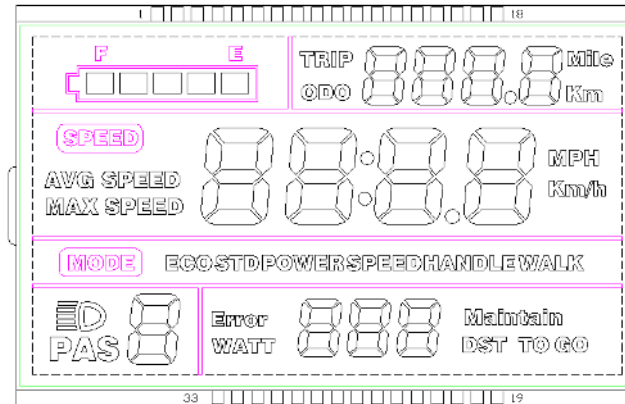

## Display Details

### 3.1 Light

### 3.2 Battery Level:



### 3.3 Multi-Functions Display

Total Mileage: ODO

Single Mileage: TRIP

Error Code: Error

Power: WATT

Maintenance: Maintain

DST TO GO: Unspecified

TRIP Error Maintain  
ODO WATT DST TO GO

### 3.4 Vehicle Mode

**MODE**

ECOSTDPOWERSPEEDHANDLEWALK

ECO: Economical Mode

STD: Standard Mode

POWER: Intensified Mode

SPEEDHANDLE: Handle-controlled Speed Mode

WALK: Walk and Push Mode

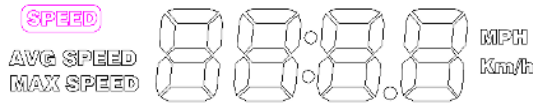

### 3.5 Speed Display

Current Speed: CUR

Maximum Speed: MAX

Average Speed: AVG

Measuring Unit: MPH or KM/H

The panel will calculate the actual travelling speed based on the wheel diameter and signal data (number of magnet steel is needed for Hall motors).



### 3.6 Error Code

Error code	definition
21	Current error
22	Throttle error(Start detection)
23	motor no phase position
24	Hall error
25	Brake error(Start detection)
30	communication display receiving error

3.7 Power Status  (levels 0-9);

Cruise Mark 

### 3.8 Settings

P01: Backlight Brightness (1: darkest; 3: brightest)

P02: Mileage Unit (0: KM; 1: MILE)

P03: Voltage Class: 24V (default) /36V / 48V

P04: Hibernation Time (0: never, other figures refer to the hibernation time) Unit: minute

P05: Power Gear – 0/3 Gear Mode: Gear 1: 2V Gear 2: 3V Gear 3: 4V

1/5 Gear Mode: Gear 1: 2V Gear 2: 2.5V Gear 3: 4V Gear 4: 3.5V Gear 5: 4V

P06: Wheel Diameter Unit: inch Precision: 0.1

P07: Magnet Steel Number for Speed Test Range: 1-100

P08: Speed Limit

Range: 0-50km/h, parameter 50 indicates no speed limit.

1. Non-communications status (panel-controlled)

When the current speed exceeds the speed limit, the PWM output will be shut down; when the current speed falls to lower than the speed limit, the PWM output will be activated and the driving speed will be set as the current speed  $\pm 1$ km/h (only applies to assist power speed, not applicable to the handlebar speed).

2. Communications status (controller-controlled)

The driving speed will be kept constant as the limited value.

Error Value:  $\pm 1$ km/h (applicable to both the assist power/handlebar speed)

Note: The above-mentioned values are measured by metric unit (kilometers). When the measuring unit is switched to imperial unit (mile), the speed value displayed on the panel will be automatically switched to corresponding imperial unit, however the speed limit value in the imperial unit interface won't change accordingly.

P09: Zero / Non-zero Start Setting:

0: Zero Start

1: Non-zero Start

#### P10: Drive Mode Setting

0: Power Drive – The specific gear of the assist drive decides the assist power value. In this status the handlebar does not work.

1: Electric Drive – The vehicle is driven by the handlebar. In this status the power gear does not work.

2: Power Drive + Electric Drive – Electric drive does not work in zero-start status.

P12: Assist Power Intensity Range: 0-5

P13: Power Magnet Steel Number: 5 / 8 / 12pcs

P14: Current Limit Value: 12A by default; Range: 1-20A

P15: Unspecified

P16: ODO Zero-Out: Long press the upper key for 5 seconds and ODO will zero out.

## 4. Keys

### Arrangement of keys on the panel:

#### Introduction of Keys

Key operations involve short press, long press and long press of combination keys.

Short press is used for short/frequent operations as:

1. Short press the two keys  to change assist power/speed during riding.

2. Short press this key  to switch the readings in the multi-function display section.

Long press on a single key is used to switch mode/on/off status.



Long press on combination keys to set parameters, which can avoid misoperations (short press on combination keys is disabled, for it's easy to induce misoperation and hard to manipulate).



## Detailed Instructions

### 1. Change Assist Power/ Electric Gear



In assist power mode

- a. Short press , assist power +1.
- b. Short press , assist power -1.

### 2. Switch Speed Display

Long press  +  to switch speed display type.

### 3. Enable / Disable 6km/h cruise, set real-time cruise and turn on/off the lights

When the vehicle is parked, long press  to enter 6km/h cruise mode. When the vehicle is travelling, long press  to enter real-time cruise mode.

Long press  to exit the cruise mode when the vehicle is in cruise mode.



Long press  to turn on/off the lights.

4. Turn on/off the LCD Panel: When the display panel is operating, long press  and it will be turned off, otherwise it will be turned on.

### 5. Switch Displayed Readings in Multi-Functions Section

Short press  to switch readings shown in the multi-functions section.

## 6. Set Parameters



Long press  +  to enter the setting interface. Customizable parameters include:

Wheel Diameter (unit: inch);

Magnet Steel Number;

Backlight Brightness;



Low Voltage Threshold (refer to setting: P01-P14)

In the setting interface, short press  or  to add/minus value to the parameter, which will blink after modified.

After selecting the parameter that needs to be set,

I. a. Long press  to save the current value, and the parameter will stop blinking;

b. Short press  to switch to the next parameter and the previously set value will be saved at the same time.

II. Press  +  to exit the setting and save the parameters. Without this operation, the system will automatically exit and save the modified parameters after 10 seconds.

**Note: Due to product upgrade, the product you purchased may be slightly different from the descriptions in this user manual, and this won't affect normal usage.**